

D C B A

axe 28

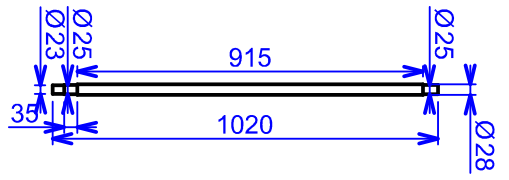

axe 35

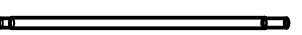
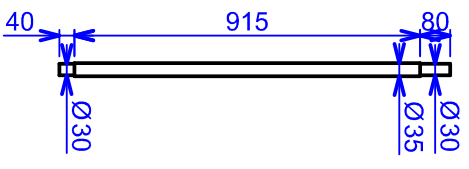

axe pour helice

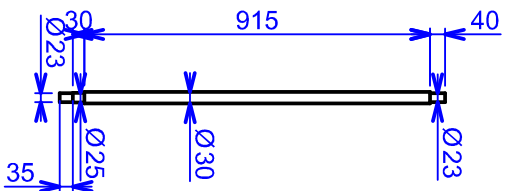

embout 90

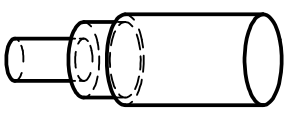
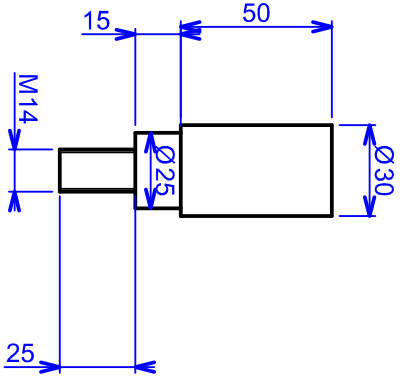

levier

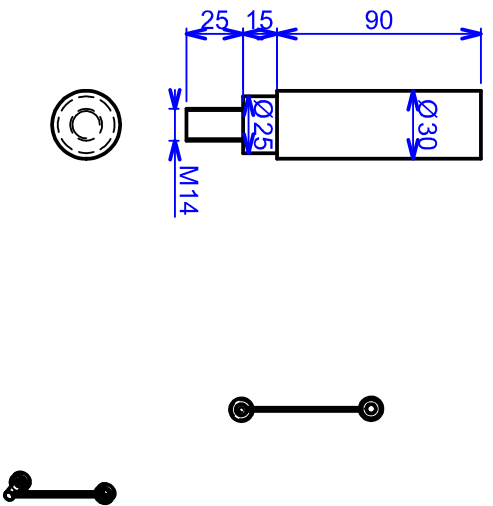

ÉCHELLE
1:1

TITRE1

AUTEUR
Deen

DATE
24/03/2014

 SOCIÉTÉ

Adresse1
Adresse2

A4

NUMÉRO DU DOCUMENT

00

D A