

plaque equerre

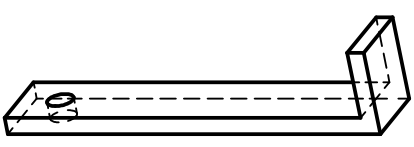

plaque support

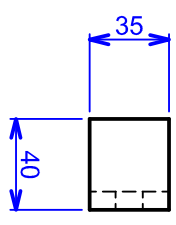
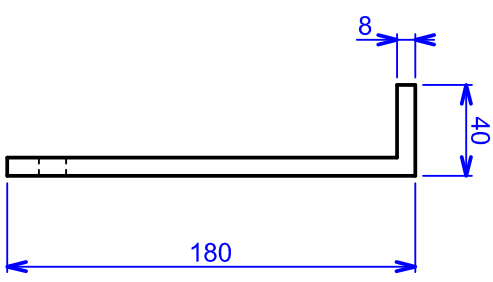
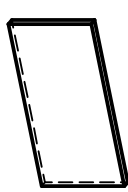
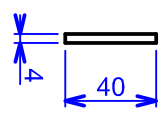
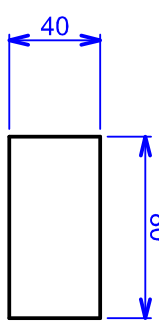

plaque verrou

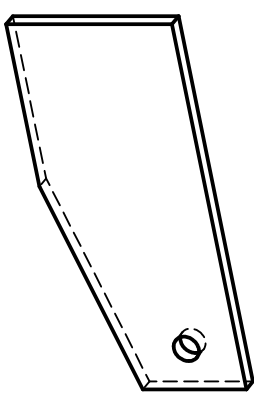
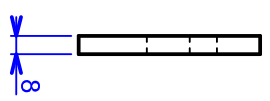
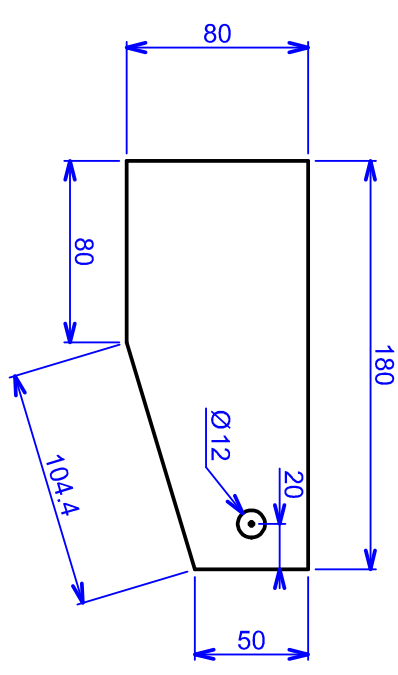

ÉCHELLE

1:1 plaque verrou- plaque support -plaque equerre

AUTEUR
Issiakou Kiram dine

DATE
24/03/2014



songhai

96482853
Adresse2

A4

NUMÉRO DU DOCUMENT

00

D

D

C

B

A

1

2

3

4

1

2

3

4